

BIRDS3 CAD Drawings

1st March 2018

+X panel

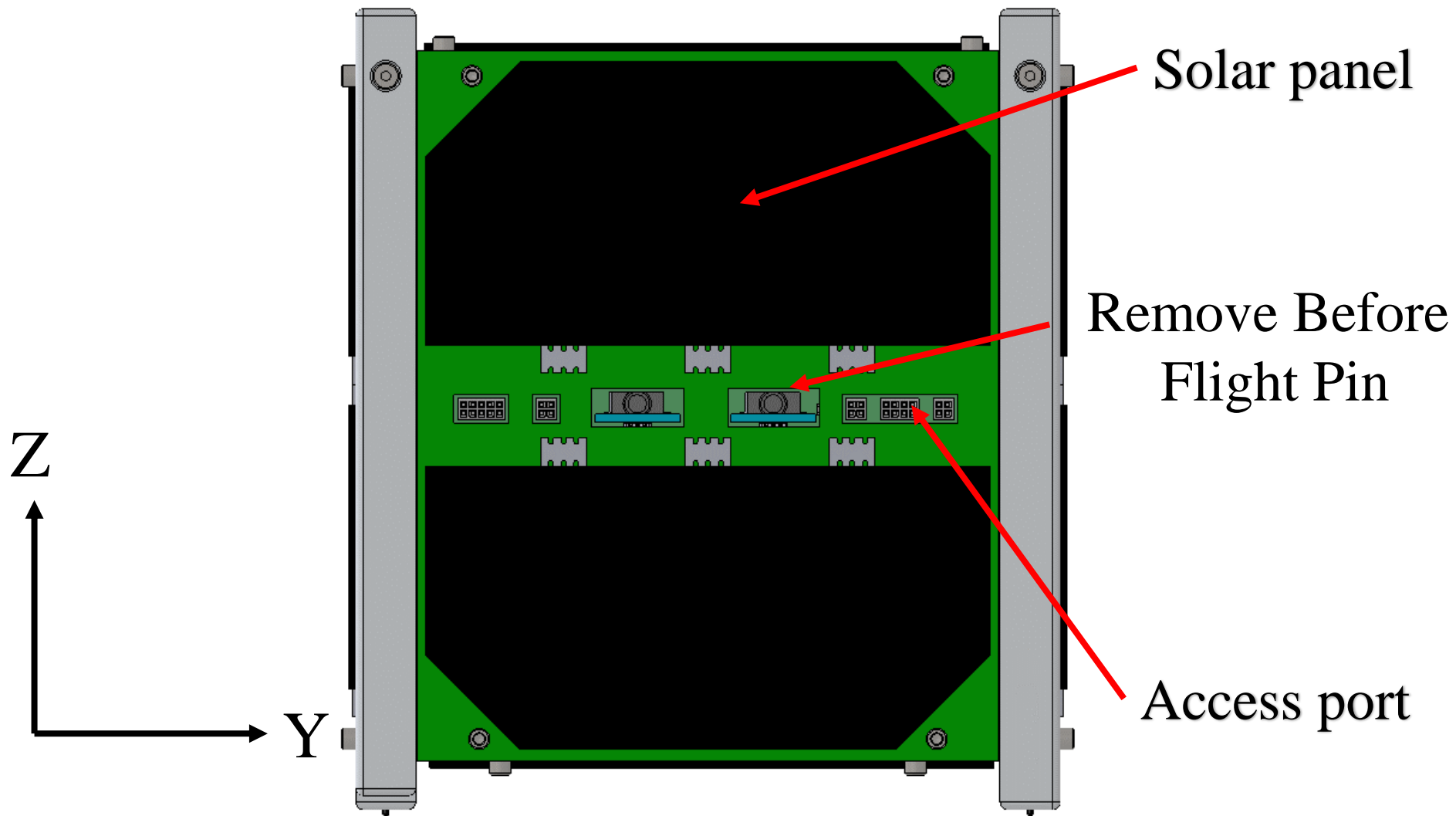

+Y panel

Solar panel

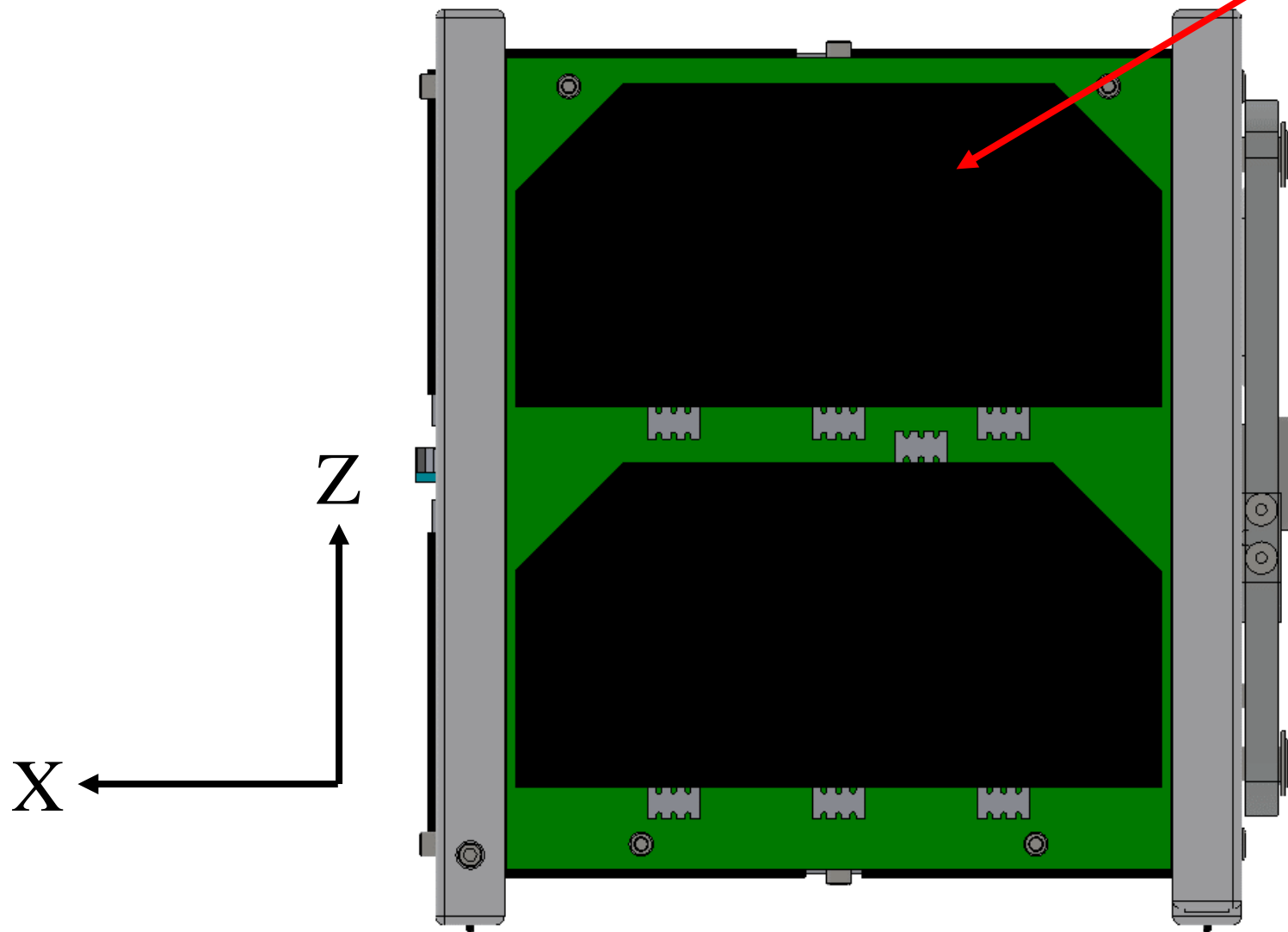

-X panel

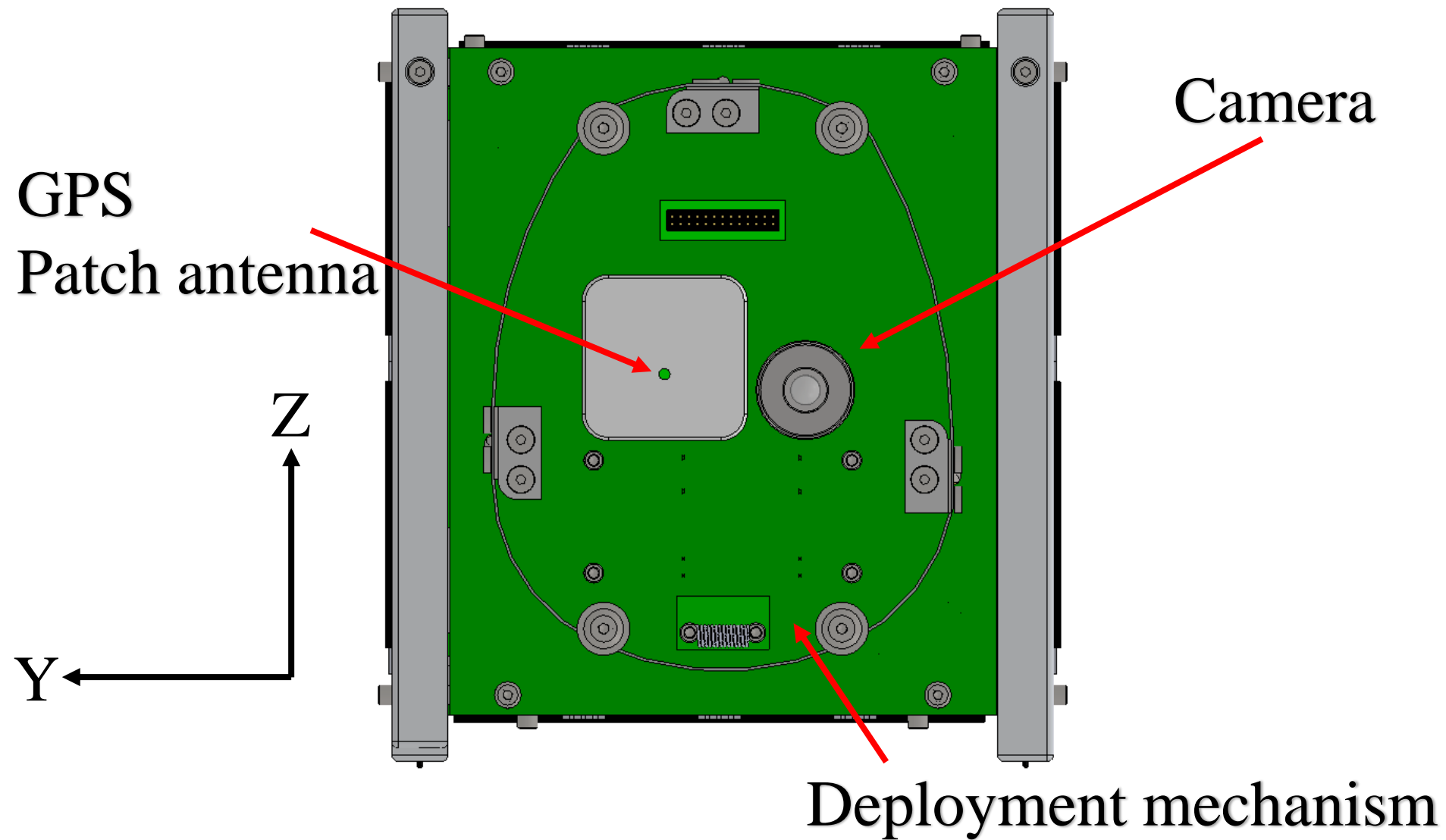

-Y panel

Solar panel

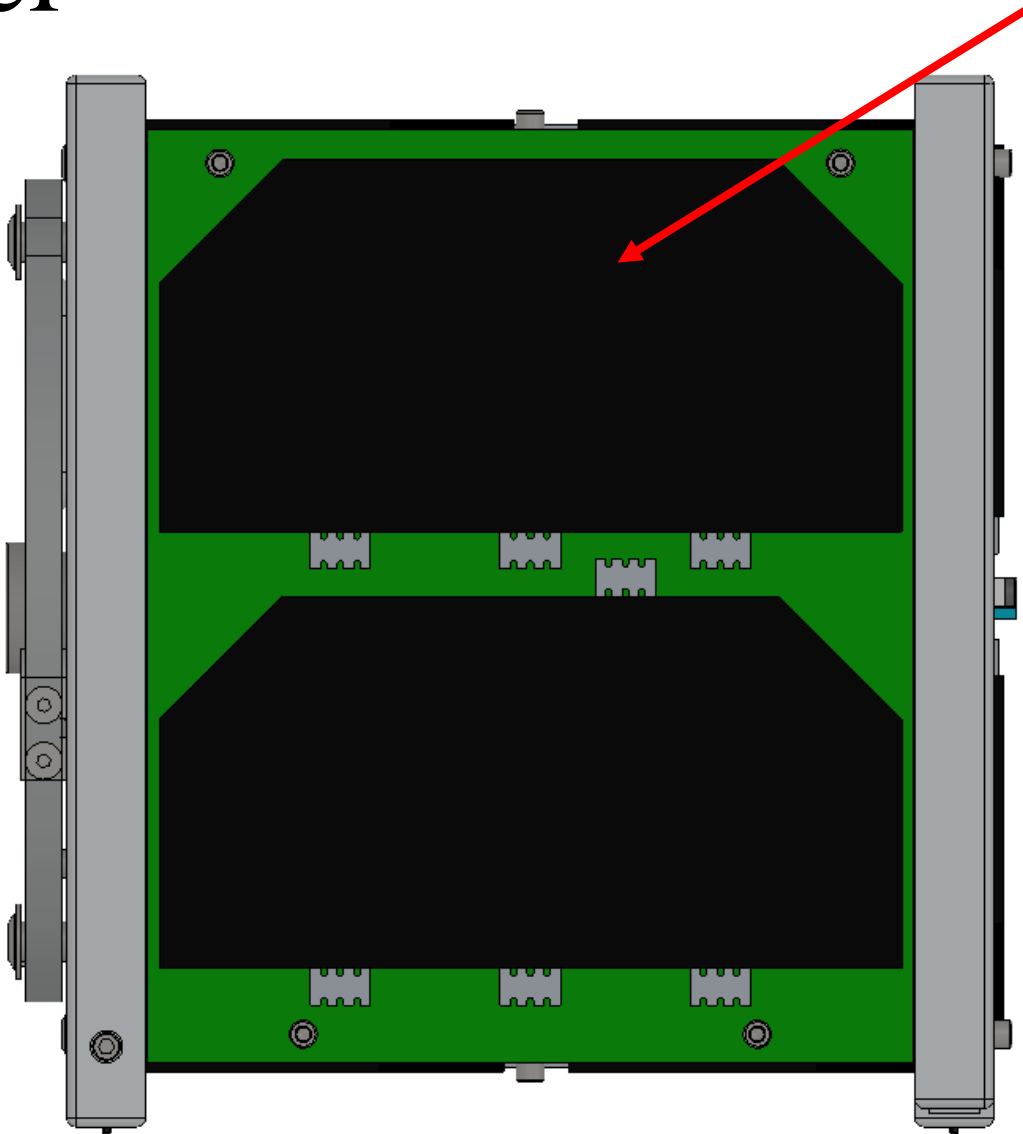
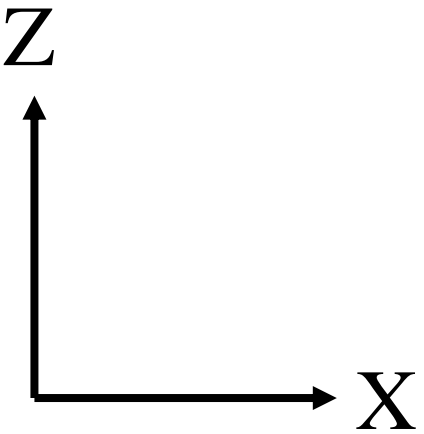

+Z panel

Solar panel

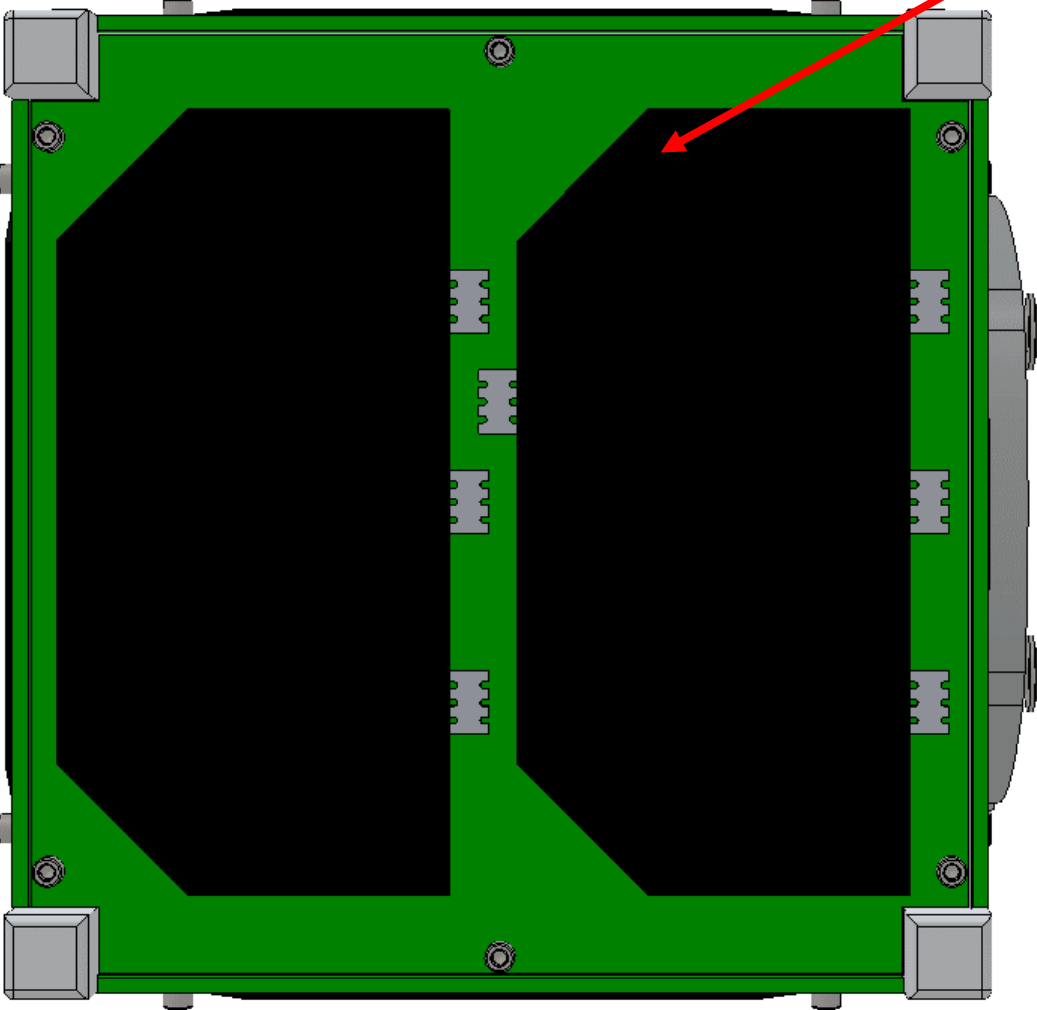
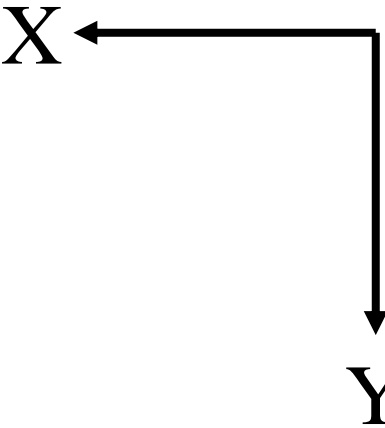

-Z panel

Solar panel

Separation
spring

Y

X

Deployment
switch

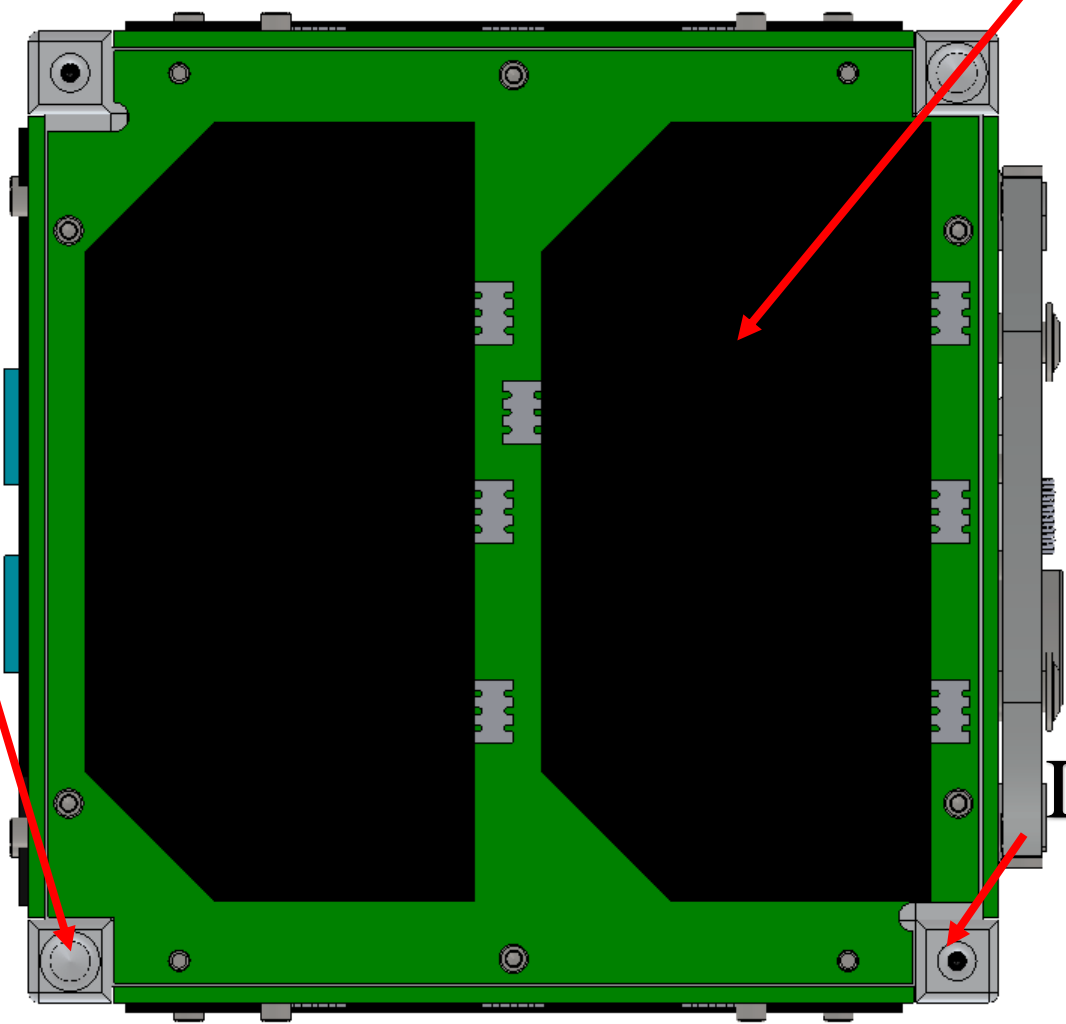

Antenna deployment

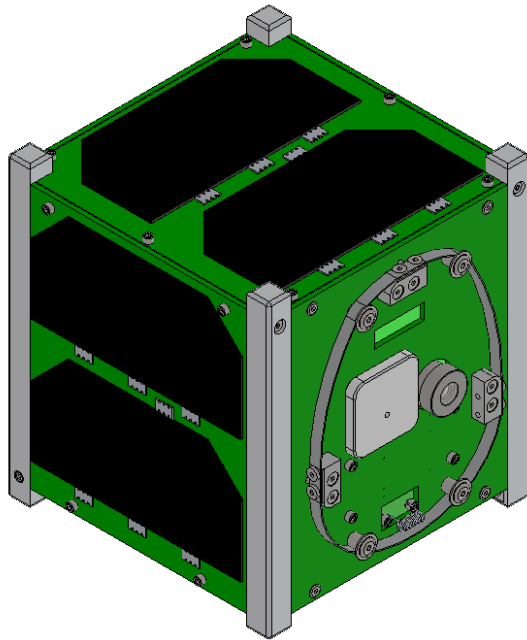

Before deployment

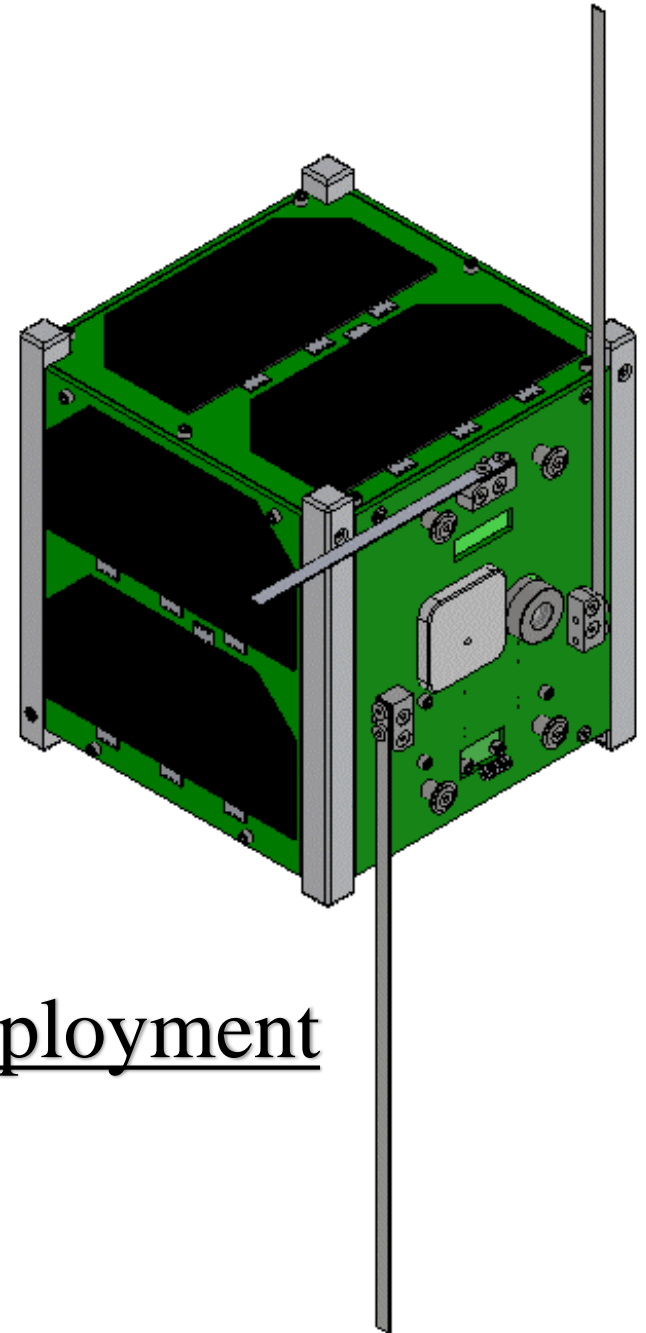
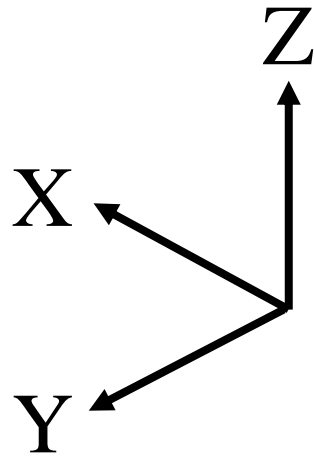

After deployment